

**Thompson Lamont Deyell  
Municipal Drain 2020  
Municipality of Morris-Turnberry  
(Turnberry Ward)**



**DIETRICH ENGINEERING LIMITED**  
CONSULTING ENGINEERS

Reference No. 1756

August 7, 2020



**TABLE OF CONTENTS**

1.0 Introduction.....1

2.0 Authorization.....1

3.0 History .....2

4.0 On-Site Meeting.....2

5.0 Findings.....2

6.0 Recommendations.....2

7.0 Environmental Considerations .....2

8.0 Working Area and Access .....2

9.0 Watershed and Soils Characteristics .....3

10.0 Allowances.....3

11.0 Estimated Construction Costs.....3

12.0 Summary of Estimated Project Costs .....3

13.0 Assessment.....4

14.0 Maintenance.....4

15.0 Schedule A – Allowances .....5

16.0 Schedule B – Estimated Construction Costs .....6

17.0 Schedule C – Assessment for Construction .....7

18.0 Schedule D – Assessment for Maintenance .....17

Appendix 1

Maitland Valley Conservation Authority – Permit To Alter A Watercourse

Specification for Construction of Municipal Drainage Works

DIVISION A – General Conditions

DIVISION B – Specification for Open Drains

DIVISION H – Special Provisions



**DIETRICH ENGINEERING LIMITED**  
CONSULTING ENGINEERS

10 Alpine Court, Kitchener, ON, N2E 2M7 | T: (519) 880-2708 | F: (519) 880-2709 | E: mail@dietricheng.com

---

Kitchener, Ontario

August 7, 2020

**Thompson Lamont Deyell Municipal Drain 2020**  
**Municipality of Morris-Turnberry**  
**(Turnberry Ward)**

To the Mayor and Council  
of the Municipality of Morris-Turnberry

Members of Council:

## **1.0 Introduction**

We are pleased to present our report on the “Thompson Lamont Deyell Municipal Drain 2020”, serving the following Lots and Concessions in the Municipality of Morris-Turnberry, Turnberry Ward, County of Huron:

Lots 10 to 30, Concession B,

Lots 23 to 30, Concession 10,

Lots 23 to 30, Concession 11,

Lots 25 to 35, Concession 12, and

In the Township of North Huron, East Wawanosh Ward, County of Huron:

Lots 30 to 35, Concession 14, and

In the Municipality of South Bruce, Culross Ward, County of Bruce:

Lots 33 to 35, Concession 1, and

In the Township of Huron-Kinloss, Kinloss Ward, County of Bruce:

Lots 1 to 12, Concession 1,

Lots 35 to 40, Concession 2

The attached Plan, and Detail Drawings No. 1 Reference No. 1756, Specifications and the Instructions to Tenderers form part of this report. They show and describe in detail the location and extent of the work to be done and the lands which are affected.

## **2.0 Authorization**

Authority to prepare this report was obtained by a resolution of the Municipality of Morris-Turnberry at its November 8, 2017 meeting to appoint Dietrich Engineering Limited to prepare an Engineer’s Report.

In accordance with your instructions pursuant to a request received by Council under Section 78 of the Drainage Act, R.S.O. 1990, signed by Edward Czerniawski, we have made an examination and survey of the affected area and submit herewith our Report which includes Drawing No. 1, Details 1 and 2 and Specifications for this work.

### 3.0 History

The existing Thompson Lamont Deyell Municipal Drain was originally constructed under the authority of a report prepared by Mr. Fred A. Edgar, P.Eng., dated June 27, 1929.

The outlet for this drain is the Maitland River in the Township of North Huron, East Wawanosh Ward.

In 1992 the maintenance assessment schedule of the existing Thompson Lamont Deyell Municipal Drain was updated to reflect the changes in ownership, lot size and land use that had occurred since 1929. This report was prepared by Maitland Engineering Services Ltd, dated June 26, 1992.

### 4.0 On-Site Meeting

In accordance with Section 9(1) of the Drainage Act, R.S.O. 1990, an on-site meeting was held on June 7, 2018. The place of meeting was the driveway at 39382 Amberly Road. Persons in attendance were:

Chris J. Dietrich    Dietrich Engineering Limited

Landowners:  
Edward & Brenda Czerniawski

### 5.0 Findings

We have made an examination of the drainage area and have found that the Edward Czerniawski property (Roll No. 15-007) is severed by the Thompson Lamont Deyell Municipal Drain and the existing 2400mm diameter culvert is failing and not of sufficient length for current farm equipment.

### 6.0 Recommendations

It is our recommendation that:

1. A new crossing be constructed on the Edward & Brenda Czerniawski property (Roll No. 15-007).
2. The new crossing shall be a 13 metre length of 2400mm diameter corrugated metal pipe laneway culvert with 125mm x 25mm corrugations and a wall thickness of 2.8mm (Type 2 Aluminized).
3. The new crossing passes the 10-year return storm with a 12 hour storm duration.

### 7.0 Environmental Considerations

An application to alter a watercourse was submitted to the Maitland Valley Conservation Authority (MVCA). MVCA approved the application and provided a permit on July 14, 2020. Permit ALT21/2020 is attached (refer to Appendix 1).

### 8.0 Working Area and Access

The landowner on whose property the culvert is to be constructed shall designate access to and from the working area.

The working area for construction and maintenance shall be the area enclosed by a 10 metre working width around the footprint of the structure.

## 9.0 Watershed and Soils Characteristics

The watershed was established through analysis of tile drainage maps, previous engineer's reports, field investigations, surveys, and data analysis of the Southwestern Ontario Orthophotographic Project (SWOOP).

The Drainage Area comprises of approximately 1891.9 hectares. Land use within the watershed is primarily agricultural and bush lands.

The Ontario Ministry of Agriculture, Food and Rural Affairs' Agricultural Information Atlas describes the soil types within the watershed and along the route of the drain as Donnybrook Sandy Loam, Dumfries Loam, Harriston Loam, and Muck.

## 10.0 Allowances

In accordance with Sections 30 of the Drainage Act, R.S.O. 1990, we have calculated Allowances payable to Landowners using the following methodology.

### 10.1 Allowances for Damages to Lands and Crops (Section 30)

Allowances for Damages to Lands and Crops under Section 30 of the Drainage Act, R.S.O. 1990 were primarily calculated to compensate landowners for crop losses, bush losses and land damages due to the construction of the drain.

We determined the allowances payable to Landowners entitled thereto as shown in Schedule A.

**Total Allowances, under Sections 30 of the Drainage Act, R.S.O. 1990; \$500**

## 11.0 Estimated Construction Costs

We have made an estimate of the cost of the proposed work based on labour, equipment and materials. A detailed description of the costs involved can be found in Schedule B of this report.

**Total estimated construction costs \$16,380**

## 12.0 Summary of Estimated Project Costs

The total estimated project costs are as follows:

Allowances under Sections 30 of the Drainage Act, R.S.O. 1990 (Refer to Schedule A)	\$ 500
Total Estimated Construction Costs (Refer to Schedule B)	\$ 16,380
Meetings, survey, design, preparation of preliminary cost estimates, preparation of final drainage report, consideration of report and attendance at the Court of Revision (if necessary)	\$ 16,100
Consultation with Environmental Agencies	\$ 2,200
Preparation of contract documents, contract administration, supervision and inspection of construction	\$ 3,500
Contingencies, Interest and net H.S.T.	\$ 1,120
<b>TOTAL ESTIMATED PROJECT COSTS – Thompson Lamont Deyell Municipal Drain 2020</b>	<b><u>\$ 39,800</u></b>

The estimated cost of the work in the Municipality of Morris-Turnberry is \$39,800.

The above costs are estimates only. The final costs of construction, engineering and administration cannot be determined until construction is completed.

The above cost estimate does not include costs associated with defending the drainage report should appeals be filed with the Drainage Tribunal and/or Drainage Referee.

### 13.0 Assessment

We assess the cost of this work against the lands and roads liable for assessment for benefit and outlet as shown in the annexed Schedule C - Assessment for Construction. We have determined that there is no injuring liability assessment involved.

### 14.0 Maintenance

After completion, this drainage crossing shall be maintained by the Municipality of Morris-Turnberry at the expense of all the lands and roads assessed in the attached Schedule of Assessment for Maintenance, until such time as the assessment is changed under the Drainage Act.

Respectfully submitted,

DIETRICH ENGINEERING LIMITED



W. J. Dietrich, P.Eng.

WJD:cjd





**Schedule A - Allowances**

<b>Lot or Part</b>	<b>Con.</b>	<b>Landowner</b>	<b>Roll No.</b>	<b>Damages to Lands and Crops (Section 30)</b>
<u>Municipality of Morris-Turnberry (Turnberry Ward)</u>				
19	B	E. Czerniawski	(15-007)	\$500
<b>Total Allowances</b>				
<b>Thompson Lamont Deyell Municipal Drain 2020</b>				<b>\$500</b>

**Schedule B - Estimated Construction Costs**

The estimated construction costs for the outlined proposed work below is as follows:

Description	Estimated Quantity	\$/Unit	Total
<u>A) Main Drain (Open)</u>			
1 Supply 1 - 2400mm diameter, 2.8mm thickness corrugated metal pipe laneway culvert (125mm X 25mm corrugations) (Type 2 Aluminized)	13 m	\$660.00	\$8,580.00
Installation of 2400mm diameter laneway culvert complete with quarry stone rip-rap protection and geotextile filter material (50m <sup>2</sup> ) and including the removal of existing 2400mm diameter culvert	l.s.		\$7,800.00
<b>TOTAL ESTIMATED CONSTRUCTION COSTS</b>			
<b>THOMPSON LAMONT DEYELL MUNICIPAL DRAIN 2020</b>			<b>\$16,380.00</b>





**Schedule C - Assessment For Construction**

TOTAL ASSESSMENT										
Lot or Part	Con. or Plan	Landowner	Roll No.	Approx. Hectares Affected	Benefit (Sec. 22)	Outlet Liability (Sec. 23)	Total Assessment	Less 1/3 Gov't Grant	Less Allowances	Net Assessment
<b><u>Municipality of Morris-Turnberry (Turnberry Ward)</u></b>										
* Pt. 10	B	W. Wideman	(20-086-35)	1.6		\$22	\$22			\$22
Pt. 11	B	C. Burke	(15-018)	2.4		\$33	\$33	\$11		\$22
* Pt. 11	B	D. & K. Kleist	(15-019)	0.1		\$5	\$5			\$5
Pt. 12	B	C. Burke	(15-018)	5.3		\$71	\$71	\$24		\$47
Pt. 13	B	K. & L. Winger	(15-020)	5.3		\$48	\$48	\$16		\$32
Pt. 14	B	K. & L. Winger	(15-020)	6.5		\$52	\$52	\$17		\$35
Pt. 15	B	P. & D. Kraayenbrink	(15-021)	7.7		\$96	\$96	\$32		\$64
Pt. 16	B	P. & D. Kraayenbrink	(15-021)	7.7		\$62	\$62	\$21		\$41
Pt. 17	B	P. & D. Kraayenbrink	(15-021)	5.7		\$46	\$46	\$15		\$31
Pt. 15	B	P. McNally	(15-022)	0.8		\$11	\$11	\$4		\$7
Pt. 16	B	P. McNally	(15-022)	1.6		\$22	\$22	\$7		\$15
Pt. 17	B	P. McNally	(15-022)	2.4		\$33	\$33	\$11		\$22
18	B	B. & M. Gibbons	(15-006)	14.2		\$128	\$128	\$43		\$85
19	B	E. Czerniawski	(15-007)	28.5	\$17,900	\$351	\$18,251	\$6,084	\$500	\$11,667
20	B	E. Czerniawski	(15-007)	36.5		\$439	\$439	\$146		\$293
21	B	Great Lakes Poultry Farms	(15-009)	40.3		\$444	\$444	\$148		\$296
22	B	Great Lakes Poultry Farms	(15-009)	40.3		\$481	\$481	\$160		\$321
23	B	Great Lakes Poultry Farms	(15-010)	40.3		\$504	\$504	\$168		\$336
24	B	A. & G. Laidlaw	(15-011)	40.3		\$397	\$397	\$132		\$265
25	B	N. & C. Edgar	(15-012)	40.3		\$444	\$444	\$148		\$296
26	B	W. & S. Pewtress	(15-013)	40.3		\$459	\$459	\$153		\$306
27	B	W. & S. Pewtress	(15-013)	40.3		\$437	\$437	\$146		\$291
28	B	J. & B. Benninger	(15-014)	40.4		\$442	\$442	\$147		\$295



**Schedule C - Assessment For Construction**

TOTAL ASSESSMENT											
Lot or Part	Con. or Plan	Landowner	Roll No.	Approx. Hectares Affected	Benefit (Sec. 22)	Outlet Liability (Sec. 23)	Total Assessment	Less 1/3 Gov't Grant	Less Allowances	Net Assessment	
Pt. 29	B	J. & B. Benninger	(15-014)	2.0		\$23	\$23	\$8		\$15	
S.Pt. 29	B	D. & P. Moore	(15-015)	19.1		\$177	\$177	\$59		\$118	
N.Pt. 29	B	D. Bannerman	(15-016)	19.2		\$155	\$155	\$52		\$103	
S.Pt. 30	B	D. & P. Moore	(15-015)	20.1		\$184	\$184	\$61		\$123	
N.Pt. 30	B	D. Wesley & M. Ducan	(15-017)	20.2		\$163	\$163	\$54		\$109	
23	10	M. McKague	(10-030)	4.0		\$54	\$54	\$18		\$36	
24	10	R. & G. Johnston	(10-031)	32.4		\$373	\$373	\$124		\$249	
25	10	R. & G. Johnston	(10-031)	40.5		\$436	\$436	\$145		\$291	
N.Pt. 26	10	J. King	(10-032)	20.2		\$241	\$241	\$80		\$161	
S.Pt. 26	10	M. Foxton	(10-032-05)	20.2		\$242	\$242	\$81		\$161	
Pt. 27	10	M. Skinn	(10-033-30)	10.1		\$90	\$90	\$30		\$60	
Pt. 27	10	R. Bushell	(10-033-40)	15.8		\$127	\$127	\$42		\$85	
Pt. 27	10	R. & S. Haanstra	(10-034)	19.8		\$255	\$255	\$85		\$170	
Pt. 28	10	R. & S. Haanstra	(10-034)	14.9		\$174	\$174	\$58		\$116	
W.Pt. 28	10	B. Lees & D. Galbraith	(10-035)	20.2		\$229	\$229	\$76		\$153	
Pt. 28	10	B. & R. Bushell	(10-036)	8.2		\$106	\$106	\$35		\$71	
29	10	M. & N. Brouillette	(10-037)	28.3		\$327	\$327	\$109		\$218	
30	10	M. & N. Brouillette	(10-037)	14.6		\$138	\$138	\$46		\$92	
23	11	M. & S. McKague	(11-025)	14.2		\$190	\$190	\$63		\$127	
* Pt. 24	11	J. Good	(11-025-15)	0.4		\$8	\$8			\$8	
24	11	KTM Family Farm Ltd.	(11-026)	32.0		\$422	\$422	\$141		\$281	
25	11	W. & M. Fenton	(11-027)	38.4		\$361	\$361	\$120		\$241	
* Pt. 25	11	G. Watson	(11-028)	0.2		\$5	\$5			\$5	
* Pt. 26	11	J. Matthews	(11-029)	1.3		\$10	\$10			\$10	



**Schedule C - Assessment For Construction**

TOTAL ASSESSMENT												
Lot or Part	Con. or Plan	Landowner	Roll No.	Approx. Hectares Affected	Benefit (Sec. 22)	Outlet Liability (Sec. 23)	Total Assessment	Less 1/3 Gov't Grant	Less Allowances	Net Assessment		
* Pt. 26	11	M. Flowers	(11-030)	25.9		\$209	\$209			\$209		
* Pt. 26	11	T. Huffman	(11-031)	7.3		\$59	\$59			\$59		
* Pt. 27	11	T. Huffman	(11-031)	17.0		\$137	\$137			\$137		
Pt. 27	11	R. & S. Haanstra	(11-032)	23.5		\$304	\$304	\$101		\$203		
28	11	R. & S. Haanstra	(11-032)	40.5		\$474	\$474	\$158		\$316		
29	11	M. Hehn	(11-033)	28.3		\$278	\$278	\$93		\$185		
* W.Pt. 30	11	R. & K. Glasgow	(11-034)	20.2		\$179	\$179			\$179		
E.Pt. 30	11	K. & L. Lewis	(11-035)	11.3		\$141	\$141	\$47		\$94		
25	12	G. & C. Gerber	(12-034)	1.2		\$13	\$13	\$4		\$9		
* 26	12	D. & S. Field	(12-035)	0.4		\$5	\$5			\$5		
27	12	D. & D. Morrison	(12-036)	3.6		\$43	\$43	\$14		\$29		
28	12	D. & B. Morrison	(12-037)	3.6		\$41	\$41	\$14		\$27		
W.Pt. 30	12	D. Becker & T. Farrell-Becker	(12-039)	1.2		\$10	\$10	\$3		\$7		
* S.Pt. 31	12	E. Kitchen	(12-040)	19.8		\$160	\$160			\$160		
* Pt. 31	12	R. & K. Glasgow	(12-041)	10.9		\$88	\$88			\$88		
* 32	12	M.V.C.A.	(12-042)	6.1		\$49	\$49			\$49		
* 33	12	M.V.C.A.	(12-042)	51.4		\$414	\$414			\$414		
* 34	12	M.V.C.A.	(12-042)	36.4		\$293	\$293			\$293		
* 35	12	E. Moore & M. Duncan	(12-043)	19.0		\$153	\$153			\$153		
Total Assessment on Lands											\$20,413	
(Municipality of Morris-Turnberry, Turnberry Ward)											\$500	
					\$17,900	\$12,567	\$30,467	\$9,554	\$500	\$20,413		



**Schedule C - Assessment For Construction**

<b>TOTAL ASSESSMENT</b>											
<b>Lot or Part</b>	<b>Con. or Plan</b>	<b>Landowner</b>	<b>Roll No.</b>	<b>Approx. Hectares Affected</b>	<b>Benefit (Sec. 22)</b>	<b>Outlet Liability (Sec. 23)</b>	<b>Total Assessment</b>	<b>Less 1/3 Gov't Grant</b>	<b>Allowances</b>	<b>Net Assessment</b>	
West Street		Municipality of Morris-Turnberry		0.2		\$8	\$8			\$8	
Gibbons Line		Municipality of Morris-Turnberry		0.8		\$43	\$43			\$43	
Sideroad 20-21		Municipality of Morris-Turnberry		4.0		\$53	\$53			\$53	
Holmes Line		Municipality of Morris-Turnberry		4.2		\$226	\$226			\$226	
Sideroad 30-31		Municipality of Morris-Turnberry		2.3		\$41	\$41			\$41	
Glenannon Road		Municipality of Morris-Turnberry		6.1		\$244	\$244			\$244	
North Street W		Municipality of Morris-Turnberry		8.7		\$200	\$200			\$200	
Turnberry Kinloss Rd.		Municipality of Morris-Turnberry		2.5		\$44	\$44			\$44	
Turnberry Culross W.		Municipality of Morris-Turnberry		1.0		\$39	\$39			\$39	
Amberley Road		County of Huron		3.6		\$195	\$195			\$195	
<b>Total Assessment on Roads</b>							<b>\$1,093</b>			<b>\$1,093</b>	
<b>(Municipality of Morris-Turnberry, Turnberry Ward)</b>											<b>\$1,093</b>
<b>Total Assessment on Lands and Roads,</b>							<b>\$17,900</b>	<b>\$13,660</b>	<b>\$500</b>	<b>\$21,506</b>	
<b>Municipality of Morris-Turnberry (Turnberry Ward)</b>											
<b><u>Township of North Huron (East Wawanosh Ward)</u></b>											
Pt. 30	14	Ross Family Farms Ltd.	(14-009)	3.9		\$36	\$36	\$12		\$24	
* Pt.30	14	M. McCormick	(14-010)	0.4		\$8	\$8			\$8	
* Pt. 30	14	K. & C. Galbraith	(14-011)	19.9		\$160	\$160			\$160	
* Pt.30	14	J. Bank	(14-013)	0.2		\$5	\$5			\$5	
* Pt.30	14	J. Franken	(14-014)	0.2		\$5	\$5			\$5	
N.Pt. 31	14	J. & E. Green	(14-015)	38.4		\$385	\$385	\$128		\$257	
S.Pt. 31	14	Ontario Peninsula Farms	(14-016)	10.1		\$94	\$94	\$31		\$63	
* Pt. 32	14	R. Foxton	(14-018)	6.9		\$70	\$70			\$70	



**Schedule C - Assessment For Construction**

<b>TOTAL ASSESSMENT</b>										
<b>Lot or Part</b>	<b>Con. or Plan</b>	<b>Landowner</b>	<b>Roll No.</b>	<b>Approx. Hectares Affected</b>	<b>Benefit (Sec. 22)</b>	<b>Outlet Liability (Sec. 23)</b>	<b>Total Assessment</b>	<b>Less 1/3 Gov't Grant</b>	<b>Less Allowances</b>	<b>Net Assessment</b>
* Pt. 32	14	C. & A. Dejong	(14-019)	6.9		\$69	\$69			\$69
Pt. 32	14	D. & S. Davidson	(14-020)	13.0		\$135	\$135	\$45		\$90
N.Pt. 33	14	N. & C. Edgar	(14-022)	18.2		\$244	\$244	\$81		\$163
S.Pt. 34	14	A. Edgar	(14-023)	1.2		\$16	\$16	\$5		\$11
* Pt. 34	14	M. & D. Ryan	(14-024)	0.4		\$8	\$8			\$8
N.Pt. 34	14	T. Schlegel	(14-027)	29.1		\$363	\$363	\$121		\$242
35	14	T. Schlegel	(14-027)	3.6		\$49	\$49	\$16		\$33
<b>Total Assessment on Lands</b>										
<b>(Township of North Huron, East Wawanosh Ward)</b>										
						\$1,647	\$1,647	\$439		\$1,208
Beecroft Line		Township of North Huron		1.7		\$70	\$70			\$70
Norman Line		Township of North Huron		1.2		\$47	\$47			\$47
Amberley Road		County of Huron		5.3		\$287	\$287			\$287
<b>Total Assessment on Roads</b>										
<b>(Township of North Huron, East Wawanosh Ward)</b>										
						\$404	\$404			\$404
<b>Total Assessment on Lands and Roads,</b>										
<b>Township of North Huron (East Wawanosh Ward)</b>										
						\$2,051	\$2,051	\$439		\$1,612
<b>Municipality of South Bruce (Culross Ward)</b>										
* Pt. 33	1	County of Bruce	(1-039)	16.2		\$130	\$130			\$130
* 34	1	County of Bruce	(1-039)	20.2		\$163	\$163			\$163
* 35	1	County of Bruce	(1-039)	7.3		\$59	\$59			\$59



**Schedule C - Assessment For Construction**

<b>TOTAL ASSESSMENT</b>										
Lot or Part	Con. or Plan	Landowner	Roll No.	Approx. Hectares Affected	Benefit (Sec. 22)	Outlet Liability (Sec. 23)	Total Assessment	Less 1/3 Gov't Grant	Allowances	Net Assessment
Pt.33	1	J. Walton	(1-079)	2.0		\$27	\$27	\$9		\$18
<b>Total Assessment on Lands</b>										
<b>(Municipality of South Bruce, Culross Ward)</b>										
Boundary Kinloss		Municipality of South Bruce		0.4		\$5	\$5			\$5
Turnberry Culross W.		Municipality of South Bruce		1.0		\$39	\$39			\$39
<b>Total Assessment on Roads</b>										
<b>(Municipality of South Bruce, Culross Ward)</b>										
						\$44	\$44			\$44
<b>Total Assessment on Lands and Roads,</b>										
<b>Municipality of South Bruce (Culross Ward)</b>										
						\$423	\$423	\$9		\$414
<b><u>Township of Huron-Kinloss (Kinloss Ward)</u></b>										
* S.Pt. 1	1	J. Younglao	(2-001)	3.7		\$50	\$50			\$50
S.Pt. 1	1	G. McIntosh	(2-001-10)	16.4		\$152	\$152	\$51		\$101
* S.Pt. 2	1	J. Younglao	(2-001)	3.7		\$50	\$50			\$50
S.Pt. 2	1	G. McIntosh	(2-001-10)	16.4		\$195	\$195	\$65		\$130
* S.Pt. 3	1	J. Deboer	(2-002)	3.2		\$37	\$37			\$37
S.Pt. 3	1	Open Valley Farms	(2-004)	16.9		\$179	\$179	\$60		\$119
S.Pt. 4	1	J. Deboer	(2-002-05)	3.6		\$44	\$44	\$15		\$29
S.Pt. 4	1	Open Valley Farms	(2-004)	16.5		\$185	\$185	\$62		\$123
S.Pt. 5	1	Open Valley Farms	(2-004)	20.1		\$248	\$248	\$83		\$165
S.Pt. 6	1	Open Valley Farms	(2-004)	20.1		\$253	\$253	\$84		\$169
S.Pt. 7	1	M. Simpson	(2-005)	20.1		\$253	\$253	\$84		\$169
S.Pt. 8	1	M. Simpson	(2-005)	18.9		\$186	\$186	\$62		\$124
S.Pt. 9	1	K. Simpson	(2-040)	15.9		\$174	\$174	\$58		\$116



**Schedule C - Assessment For Construction**

TOTAL ASSESSMENT										
Lot or Part	Con. or Plan	Landowner	Roll No.	Approx. Hectares Affected	Benefit (Sec. 22)	Outlet Liability (Sec. 23)	Total Assessment	Less 1/3 Gov't Grant	Less Allowances	Net Assessment
S.Pt. 10	1	K. Simpson	(2-040)	11.3		\$135	\$135	\$45		\$90
* S.Pt. 11	1	J. Kikkert	(2-041)	2.0		\$27	\$27			\$27
S.Pt. 11	1	E. Miller	(2-065)	4.5		\$55	\$55	\$18		\$37
S.Pt. 12	1	E. Miller	(2-065)	1.6		\$20	\$20	\$7		\$13
N.Pt. 1	1	M. Duncan	(2-084)	20.2		\$224	\$224	\$75		\$149
N.Pt. 2	1	M. Duncan	(2-084)	20.2		\$173	\$173	\$58		\$115
N.Pt. 3	1	C. Whytock	(2-085)	20.2		\$229	\$229	\$76		\$153
N.Pt. 4	1	C. Whytock	(2-085)	20.2		\$229	\$229	\$76		\$153
N.Pt. 5	1	D. Wall	(2-086)	20.2		\$207	\$207	\$69		\$138
N.Pt. 6	1	D. Wall	(2-086)	20.2		\$207	\$207	\$69		\$138
N.Pt. 7	1	M. Simpson	(2-087)	16.6		\$217	\$217	\$72		\$145
* N.Pt. 7	1	S. Anderson	(2-087-01)	3.6		\$46	\$46			\$46
N.Pt. 8	1	M. Simpson	(2-087)	12.1		\$152	\$152	\$51		\$101
* N.Pt. 8	1	S. Anderson	(2-087-01)	2.4		\$33	\$33			\$33
N.Pt. 9	1	K. Simpson	(2-088)	8.1		\$109	\$109	\$36		\$73
N.Pt. 10	1	K. Simpson	(2-088)	2.0		\$23	\$23	\$8		\$15
35	2	D. Ross	(2-123)	12.1		\$163	\$163	\$54		\$109
Pt. 36	2	M. Simpson	(2-124)	9.9		\$132	\$132	\$44		\$88
* Pt. 36	2	J. Albrecht	(2-124-10)	1.5		\$20	\$20			\$20
37	2	D. Ross	(2-125)	11.3		\$130	\$130	\$43		\$87
* 38	2	Whitechurch Farms Ltd.	(2-126)	13.0		\$169	\$169			\$169
* Pt. 39	2	Whitechurch Farms Ltd.	(2-127)	6.5		\$87	\$87			\$87
Pt. 39	2	R. Christy	(2-128)	0.8		\$7	\$7	\$2		\$5
40	2	R. Christy	(2-128)	20.2		\$211	\$211	\$70		\$141



**Schedule C - Assessment For Construction**

TOTAL ASSESSMENT										
Lot or Part	Con. or Plan	Landowner	Roll No.	Approx. Hectares Affected	Benefit (Sec. 22)	Outlet Liability (Sec. 23)	Total Assessment	Less 1/3 Gov't Grant	Allowances	Net Assessment
<b>Township of Huron-Kinloss (Whitechurch Ward)</b>										
* 32	293	M. Joseph	(2-006)	0.07		\$5	\$5			\$5
* 31	293	M. Joseph	(2-007)	0.07		\$5	\$5			\$5
* Pt. 9	293	Township of Huron-Kinloss	(2-008)	1.12		\$22	\$22			\$22
* 30	293	T. Falconer	(2-009)	0.07		\$5	\$5			\$5
* 29	293	C. Dale	(2-010)	0.07		\$5	\$5			\$5
* 28	293	D. Ross	(2-011)	0.04		\$5	\$5			\$5
* 26 & 27	293	D. Preiss	(2-013)	0.07		\$5	\$5			\$5
* 25	293	M. Lyons	(2-014)	0.04		\$5	\$5			\$5
* Pt. 10	1	M. Thomson	(2-015)	0.05		\$5	\$5			\$5
* Pt. 10	1	J. Hogg	(2-016)	0.05		\$5	\$5			\$5
* Pt. 10	1	L. Smits	(2-017)	0.08		\$5	\$5			\$5
* Pt. 10	1	M. Carriere	(2-018)	2.26		\$32	\$32			\$32
* 4	153	D. Metcalfe	(2-023)	0.04		\$5	\$5			\$5
* 5	153	J. Franken	(2-024)	0.08		\$5	\$5			\$5
* 6	153	J. Dickie	(2-025)	0.08		\$5	\$5			\$5
* 7	153	I. Walker	(2-026)	0.06		\$5	\$5			\$5
* 8	153	C. Humphrey	(2-027)	0.08		\$5	\$5			\$5
* Pt. 10	1	A. Pennington	(2-028)	0.57		\$9	\$9			\$9
* 11	225	R. Ward	(2-031)	0.10		\$5	\$5			\$5
* 12	225	A. Furness	(2-032)	0.10		\$5	\$5			\$5
* 13	225	L. Graumans	(2-033)	0.10		\$5	\$5			\$5
* 14	225	K. Moore	(2-034)	0.10		\$5	\$5			\$5
* 15	225	H. Turner	(2-035)	0.10		\$5	\$5			\$5





**Schedule C - Assessment For Construction**

TOTAL ASSESSMENT										
Lot or Part	Con. or Plan	Landowner	Roll No.	Approx. Hectares Affected (Sec. 22)	Benefit (Sec. 22)	Outlet Liability (Sec. 23)	Total Assessment	Less 1/3 Gov't Grant	Allowances	Net Assessment
* 16, 17, 18	225	J. Hughes	(2-036)	0.30		\$5	\$5			\$5
* Pt. 10	1	W. Simpson	(2-036-10)	0.13		\$5	\$5			\$5
* Pt. 10	1	J. Lettau	(2-039)	0.21		\$5	\$5			\$5
* Pt. 10	1	M. Simpson	(2-039-01)	0.16		\$5	\$5			\$5
* Pt. 10	1	R. Harris	(2-039-02)	0.16		\$5	\$5			\$5
* 18	226	S. Sutherland	(2-045)	0.23		\$5	\$5			\$5
* Pt. 11	1	G. Potter	(2-045-20)	0.73		\$10	\$10			\$10
* Pt. 11	1	J. Sheperd	(2-046)	0.21		\$5	\$5			\$5
* 17	226	D. Thompson	(2-047)	0.08		\$5	\$5			\$5
* Pt. 16	226	M. Shaik	(2-048)	0.08		\$5	\$5			\$5
* 15, 16	226	J. Franken	(2-049)	0.08		\$5	\$5			\$5
* 14, 15	226	G. Hoggarth	(2-050)	0.10		\$5	\$5			\$5
* 13	226	A. Gregory	(2-051)	0.08		\$5	\$5			\$5
* 12	226	A. Gregory	(2-051)	0.08		\$5	\$5			\$5
* 11	226	K. Hildenbrandt	(2-054)	0.08		\$5	\$5			\$5
* 10	226	T. Wright	(2-053)	0.08		\$5	\$5			\$5
* 9	226	M. Taylor	(2-055)	0.08		\$5	\$5			\$5
* 8	226	J. Little	(2-056)	0.08		\$5	\$5			\$5
* 7	226	B. Benninger	(2-057)	0.08		\$5	\$5			\$5
* 6	226	J. Coulter	(2-058)	0.08		\$5	\$5			\$5
* 5	226	P. Brink	(2-059)	0.08		\$5	\$5			\$5
* 4	226	J. Gibson	(2-060)	0.08		\$5	\$5			\$5
* 3	226	Township of Huron-Kinloss	(2-061)	0.06		\$5	\$5			\$5
Total Assessments on Lands (Township of Huron-Kinloss)							\$5,294	\$1,497		\$3,797



**Schedule C - Assessment For Construction**

TOTAL ASSESSMENT										
Lot or Part	Con. or Plan	Landowner	Roll No.	Approx. Hectares Affected	Benefit (Sec. 22)	Outlet Liability (Sec. 23)	Total Assessment	Less 1/3 Gov't Grant	Less Allowances	Net Assessment
Whitechurch Street		Township of Huron-Kinloss		2.3		\$126	\$126			\$126
S Kinloss Ave		Township of Huron-Kinloss		4.2		\$169	\$169			\$169
Boundary Culloss		Township of Huron-Kinloss		0.4		\$5	\$5			\$5
Turnberry Kinloss Rd.		Township of Huron-Kinloss		2.5		\$33	\$33			\$33
Amberley Road		County of Bruce		2.6		\$139	\$139			\$139
Total Assessment on Roads (Township of Huron-Kinloss)							\$472			\$472
<b>Total Assessment on Lands and Roads, Township of Huron-Kinloss</b>							<b>\$5,766</b>	<b>\$1,497</b>	<b>\$500</b>	<b>\$4,269</b>
<b>Total Assessment on Lands and Roads Thompson Lamont Deyell Municipal Drain 2020</b>							<b>\$39,800</b>	<b>\$11,499</b>	<b>\$500</b>	<b>\$27,801</b>

NOTES:

1. \* Denotes lands not eligible for ADIP grants.
2. The NET ASSESSMENT is the total estimated assessment less a one-third (1/3) Provincial grant, and allowances, if applicable.
3. The NET ASSESSMENT is provided for information purposes only.

**Schedule D - Assessment For Maintenance**

Lot or Part	Con.	Landowner	Roll No.	Approx. Hectares Affected	Portion of Maintenance Cost
<b><u>Municipality of Morris-Turnberry (Turnberry Ward)</u></b>					
* Pt. 10	B	W. Wideman	(20-086-35)	1.6	0.05%
Pt. 11	B	C. Burke	(15-018)	2.4	0.07%
* Pt. 11	B	D. & K. Kleist	(15-019)	0.1	0.01%
Pt. 12	B	C. Burke	(15-018)	5.3	0.16%
Pt. 13	B	K. & L. Winger	(15-020)	5.3	0.11%
Pt. 14	B	K. & L. Winger	(15-020)	6.5	0.12%
Pt. 15	B	P. & D. Kraayenbrink	(15-021)	7.7	0.22%
Pt. 16	B	P. & D. Kraayenbrink	(15-021)	7.7	0.14%
Pt. 17	B	P. & D. Kraayenbrink	(15-021)	5.7	0.10%
Pt. 15	B	P. McNally	(15-022)	0.8	0.02%
Pt. 16	B	P. McNally	(15-022)	1.6	0.05%
Pt. 17	B	P. McNally	(15-022)	2.4	0.07%
18	B	B. & M. Gibbons	(15-006)	14.2	0.29%
19	B	E. Czerniawski	(15-007)	28.5	50.91%
20	B	E. Czerniawski	(15-007)	36.5	1.01%
21	B	Great Lakes Poultry Farms	(15-009)	40.3	1.02%
22	B	Great Lakes Poultry Farms	(15-009)	40.3	1.11%
23	B	Great Lakes Poultry Farms	(15-010)	40.3	1.16%
24	B	A. & G. Laidlaw	(15-011)	40.3	0.91%
25	B	N. & C. Edgar	(15-012)	40.3	1.02%
26	B	W. & S. Pewtress	(15-013)	40.3	1.06%
27	B	W. & S. Pewtress	(15-013)	40.3	1.00%
28	B	J. & B. Benninger	(15-014)	40.4	1.02%
Pt. 29	B	J. & B. Benninger	(15-014)	2.0	0.05%
S.Pt. 29	B	D. & P. Moore	(15-015)	19.1	0.41%
N.Pt. 29	B	D. Bannerman	(15-016)	19.2	0.36%
S.Pt. 30	B	D. & P. Moore	(15-015)	20.1	0.42%
N.Pt. 30	B	D. Wesley & M. Ducan	(15-017)	20.2	0.37%
23	10	M. McKague	(10-030)	4.0	0.12%
24	10	R. & G. Johnston	(10-031)	32.4	0.86%
25	10	R. & G. Johnston	(10-031)	40.5	1.00%

**Schedule D - Assessment For Maintenance**

Lot or Part	Con.	Landowner	Roll No.	Approx. Hectares Affected	Portion of Maintenance Cost
N.Pt. 26	10	J. King	(10-032)	20.2	0.55%
S.Pt. 26	10	M. Foxton	(10-032-05)	20.2	0.56%
Pt. 27	10	M. Skinn	(10-033-30)	10.1	0.21%
Pt. 27	10	R. Bushell	(10-033-40)	15.8	0.29%
Pt. 27	10	R. & S. Haanstra	(10-034)	19.8	0.59%
Pt. 28	10	R. & S. Haanstra	(10-034)	14.9	0.40%
W.Pt. 28	10	B. Lees & D. Galbraith	(10-035)	20.2	0.53%
Pt. 28	10	B. & R. Bushell	(10-036)	8.2	0.24%
29	10	M. & N. Brouillette	(10-037)	28.3	0.75%
30	10	M. & N. Brouillette	(10-037)	14.6	0.32%
23	11	M. & S. McKague	(11-025)	14.2	0.44%
* Pt. 24	11	J. Good	(11-025-15)	0.4	0.02%
24	11	KTM Family Farm Ltd.	(11-026)	32.0	0.97%
25	11	W. & M. Fenton	(11-027)	38.4	0.83%
* Pt. 25	11	G. Watson	(11-028)	0.2	0.01%
* Pt. 26	11	J. Matthews	(11-029)	1.3	0.02%
* Pt. 26	11	M. Flowers	(11-030)	25.9	0.48%
* Pt. 26	11	T. Huffman	(11-031)	7.3	0.13%
* Pt. 27	11	T. Huffman	(11-031)	17.0	0.31%
Pt. 27	11	R. & S. Haanstra	(11-032)	23.5	0.70%
28	11	R. & S. Haanstra	(11-032)	40.5	1.09%
29	11	M. Hehn	(11-033)	28.3	0.64%
* W.Pt. 30	11	R. & K. Glasgow	(11-034)	20.2	0.41%
E.Pt. 30	11	K. & L. Lewis	(11-035)	11.3	0.32%
25	12	G. & C. Gerber	(12-034)	1.2	0.03%
* 26	12	D. & S. Field	(12-035)	0.4	0.01%
27	12	D. & D. Morrison	(12-036)	3.6	0.10%
28	12	D. & B. Morrison	(12-037)	3.6	0.09%
W.Pt. 30	12	D. Becker & T. Farrell-Becker	(12-039)	1.2	0.02%
* S.Pt. 31	12	E. Kitchen	(12-040)	19.8	0.37%
* Pt. 31	12	R. & K. Glasgow	(12-041)	10.9	0.20%
* 32	12	M.V.C.A.	(12-042)	6.1	0.11%

**Schedule D - Assessment For Maintenance**

Lot or Part	Con.	Landowner	Roll No.	Approx. Hectares Affected	Portion of Maintenance Cost
* 33	12	M.V.C.A.	(12-042)	51.4	0.95%
* 34	12	M.V.C.A.	(12-042)	36.4	0.67%
* 35	12	E. Moore & M. Duncan	(12-043)	19.0	0.35%
Total Assessment on Lands (Municipality of Morris-Turnberry, Turnberry Ward)					78.9%
West Street		Municipality of Morris-Turnberry		0.2	0.02%
Gibbons Line		Municipality of Morris-Turnberry		0.8	0.10%
Sideroad 20-21		Municipality of Morris-Turnberry		4.0	0.12%
Holmes Line		Municipality of Morris-Turnberry		4.2	0.52%
Sideroad 30-31		Municipality of Morris-Turnberry		2.3	0.09%
Glenannon Road		Municipality of Morris-Turnberry		6.1	0.56%
North Street W		Municipality of Morris-Turnberry		8.7	0.46%
Turnberry Kinloss Rd.		Municipality of Morris-Turnberry		2.5	0.10%
Turnberry Culross W.		Municipality of Morris-Turnberry		1.0	0.09%
Amberley Road		County of Huron		3.6	0.45%
Total Assessment on Roads (Municipality of Morris-Turnberry, Turnberry Ward)					2.51%
<b>Total Assessment on Lands and Roads, Municipality of Morris-Turnberry (Turnberry Ward)</b>					<b>81.41%</b>
<b><u>Township of North Huron (East Wawanosh Ward)</u></b>					
Pt. 30	14	Ross Family Farms Ltd.	(14-009)	3.9	0.08%
* Pt.30	14	M. McCormick	(14-010)	0.4	0.02%
* Pt. 30	14	K. & C. Galbraith	(14-011)	19.9	0.37%
* Pt.30	14	J. Bank	(14-013)	0.2	0.01%
* Pt.30	14	J. Franken	(14-014)	0.2	0.01%
N.Pt. 31	14	J. & E. Green	(14-015)	38.4	0.88%
S.Pt. 31	14	Ontario Peninsula Farms	(14-016)	10.1	0.22%
* Pt. 32	14	R. Foxton	(14-018)	6.9	0.16%
* Pt. 32	14	C. & A. Dejong	(14-019)	6.9	0.16%

**Schedule D - Assessment For Maintenance**

Lot or Part	Con.	Landowner	Roll No.	Approx. Hectares Affected	Portion of Maintenance Cost
Pt. 32	14	D. & S. Davidson	(14-020)	13.0	0.31%
N.Pt. 33	14	N. & C. Edgar	(14-022)	18.2	0.56%
S.Pt. 34	14	A. Edgar	(14-023)	1.2	0.04%
* Pt. 34	14	M. & D. Ryan	(14-024)	0.4	0.02%
N.Pt. 34	14	T. Schlegel	(14-027)	29.1	0.83%
35	14	T. Schlegel	(14-027)	3.6	0.11%
Total Assessment on Lands (Township of North Huron, East Wawanosh Ward)					3.78%
Beecroft Line		Township of North Huron		1.7	0.16%
Norman Line		Township of North Huron		1.2	0.11%
Amberley Road		County of Huron		5.3	0.66%
Total Assessment on Roads (Township of North Huron, East Wawanosh Ward)					0.93%
<b>Total Assessment on Lands and Roads, Township of North Huron (East Wawanosh Ward)</b>					<b>4.71%</b>
<b><u>Municipality of South Bruce (Culross Ward)</u></b>					
* Pt. 33	1	County of Bruce	(1-039)	16.2	0.30%
* 34	1	County of Bruce	(1-039)	20.2	0.37%
* 35	1	County of Bruce	(1-039)	7.3	0.13%
Pt.33	1	J. Walton	(1-079)	2.0	0.06%
Total Assessment on Lands (Municipality of South Bruce, Culross Ward)					0.86%
Boundary Kinloss		Municipality of South Bruce		0.4	0.01%
Turnberry Culross W.		Municipality of South Bruce		1.0	0.09%
Total Assessment on Roads (Municipality of South Bruce, Culross Ward)					0.10%

**Schedule D - Assessment For Maintenance**

Lot or Part	Con.	Landowner	Roll No.	Approx. Hectares Affected	Portion of Maintenance Cost
<b>Total Assessment on Lands and Roads, Municipality of South Bruce (Culross Ward)</b>					<b>0.96%</b>

**Township of Huron-Kinloss (Kinloss Ward)**

* S.Pt. 1	1	J. Younglao	(2-001)	3.7	0.11%
S.Pt. 1	1	G. McIntosh	(2-001-10)	16.4	0.35%
* S.Pt. 2	1	J. Younglao	(2-001)	3.7	0.11%
S.Pt. 2	1	G. McIntosh	(2-001-10)	16.4	0.45%
* S.Pt. 3	1	J. Deboer	(2-002)	3.2	0.08%
S.Pt. 3	1	Open Valley Farms	(2-004)	16.9	0.41%
S.Pt. 4	1	J. Deboer	(2-002-05)	3.6	0.10%
S.Pt. 4	1	Open Valley Farms	(2-004)	16.5	0.42%
S.Pt. 5	1	Open Valley Farms	(2-004)	20.1	0.57%
S.Pt. 6	1	Open Valley Farms	(2-004)	20.1	0.58%
S.Pt. 7	1	M. Simpson	(2-005)	20.1	0.58%
S.Pt. 8	1	M. Simpson	(2-005)	18.9	0.43%
S.Pt. 9	1	K. Simpson	(2-040)	15.9	0.40%
S.Pt. 10	1	K. Simpson	(2-040)	11.3	0.31%
* S.Pt. 11	1	J. Kikkert	(2-041)	2.0	0.06%
S.Pt. 11	1	E. Miller	(2-065)	4.5	0.13%
S.Pt. 12	1	E. Miller	(2-065)	1.6	0.04%
N.Pt. 1	1	M. Duncan	(2-084)	20.2	0.51%
N.Pt. 2	1	M. Duncan	(2-084)	20.2	0.40%
N.Pt. 3	1	C. Whytock	(2-085)	20.2	0.53%
N.Pt. 4	1	C. Whytock	(2-085)	20.2	0.53%
N.Pt. 5	1	D. Wall	(2-086)	20.2	0.48%
N.Pt. 6	1	D. Wall	(2-086)	20.2	0.48%
N.Pt. 7	1	M. Simpson	(2-087)	16.6	0.50%
* N.Pt. 7	1	S. Anderson	(2-087-01)	3.6	0.10%
N.Pt. 8	1	M. Simpson	(2-087)	12.1	0.35%
* N.Pt. 8	1	S. Anderson	(2-087-01)	2.4	0.07%
N.Pt. 9	1	K. Simpson	(2-088)	8.1	0.25%

**Schedule D - Assessment For Maintenance**

Lot or Part	Con.	Landowner	Roll No.	Approx. Hectares Affected	Portion of Maintenance Cost
N.Pt. 10	1	K. Simpson	(2-088)	2.0	0.05%
35	2	D. Ross	(2-123)	12.1	0.37%
Pt. 36	2	M. Simpson	(2-124)	9.9	0.30%
* Pt. 36	2	J. Albrecht	(2-124-10)	1.5	0.04%
37	2	D. Ross	(2-125)	11.3	0.30%
* 38	2	Whitechurch Farms Ltd.	(2-126)	13.0	0.39%
* Pt. 39	2	Whitechurch Farms Ltd.	(2-127)	6.5	0.20%
Pt. 39	2	R. Christy	(2-128)	0.8	0.02%
40	2	R. Christy	(2-128)	20.2	0.48%

**Township of Huron-Kinloss (Whitechurch Ward)**

* 32	293	M. Joseph	(2-006)	0.07	0.003%
* 31	293	M. Joseph	(2-007)	0.07	0.003%
* Pt. 9	293	Township of Huron-Kinloss	(2-008)	1.12	0.052%
* 30	293	T. Falconer	(2-009)	0.07	0.003%
* 29	293	C. Dale	(2-010)	0.07	0.003%
* 28	293	D. Ross	(2-011)	0.04	0.002%
* 26 & 27	293	D. Preiss	(2-013)	0.07	0.003%
* 25	293	M. Lyons	(2-014)	0.04	0.002%
* Pt. 10	1	M. Thomson	(2-015)	0.05	0.002%
* Pt. 10	1	J. Hogg	(2-016)	0.05	0.002%
* Pt. 10	1	L. Smits	(2-017)	0.08	0.004%
* Pt. 10	1	M. Carriere	(2-018)	2.26	0.072%
* 4	153	D. Metcalfe	(2-023)	0.04	0.002%
* 5	153	J. Franken	(2-024)	0.08	0.004%
* 6	153	J. Dickie	(2-025)	0.08	0.004%
* 7	153	I. Walker	(2-026)	0.06	0.003%
* 8	153	C. Humphrey	(2-027)	0.08	0.004%
* Pt. 10	1	A. Pennington	(2-028)	0.57	0.020%
* 11	225	R. Ward	(2-031)	0.10	0.005%
* 12	225	A. Furness	(2-032)	0.10	0.005%
* 13	225	L. Graumans	(2-033)	0.10	0.005%



**Schedule D - Assessment For Maintenance**

Lot or Part	Con.	Landowner	Roll No.	Approx. Hectares Affected	Portion of Maintenance Cost
* 14	225	K. Moore	(2-034)	0.10	0.005%
* 15	225	H. Turner	(2-035)	0.10	0.005%
* 16, 17, 18	225	J. Hughes	(2-036)	0.30	0.012%
* Pt. 10	1	W. Simpson	(2-036-10)	0.13	0.004%
* Pt. 10	1	J. Lettau	(2-039)	0.21	0.010%
* Pt. 10	1	M. Simpson	(2-039-01)	0.16	0.005%
* Pt. 10	1	R. Harris	(2-039-02)	0.16	0.007%
* 18	226	S. Sutherland	(2-045)	0.23	0.009%
* Pt. 11	1	G. Potter	(2-045-20)	0.73	0.020%
* Pt. 11	1	J. Sheperd	(2-046)	0.21	0.010%
* 17	226	D. Thompson	(2-047)	0.08	0.004%
* Pt. 16	226	M. Shaik	(2-048)	0.08	0.004%
* 15, 16	226	J. Franken	(2-049)	0.08	0.004%
* 14, 15	226	G. Hoggarth	(2-050)	0.10	0.005%
* 13	226	A. Gregory	(2-051)	0.08	0.004%
* 12	226	A. Gregory	(2-051)	0.08	0.004%
* 11	226	K. Hildenbrandt	(2-054)	0.08	0.004%
* 10	226	T. Wright	(2-053)	0.08	0.004%
* 9	226	M. Taylor	(2-055)	0.08	0.004%
* 8	226	J. Little	(2-056)	0.08	0.004%
* 7	226	B. Benninger	(2-057)	0.08	0.004%
* 6	226	J. Coulter	(2-058)	0.08	0.004%
* 5	226	P. Brink	(2-059)	0.08	0.004%
* 4	226	J. Gibson	(2-060)	0.08	0.004%
* 3	226	Township of Huron-Kinloss	(2-061)	0.06	0.003%
<b>Total Assessments on Lands (Township of Huron-Kinloss)</b>					<b>11.83%</b>

**Schedule D - Assessment For Maintenance**

Lot or Part	Con.	Landowner	Roll No.	Approx. Hectares Affected	Portion of Maintenance Cost
Whitechurch Street		Township of Huron-Kinloss		2.3	0.29%
S Kinloss Ave		Township of Huron-Kinloss		4.2	0.39%
Boundary Culross		Township of Huron-Kinloss		0.4	0.01%
Turnberry Kinloss Rd.		Township of Huron-Kinloss		2.5	0.08%
Amberley Road		County of Bruce		2.6	0.32%
Total Assessment on Roads (Township of Huron-Kinloss)					1.09%
<b>Total Assessment on Lands and Roads, Township of Huron-Kinloss</b>					<b>12.92%</b>
Total Assessment on Lands and Roads Thompson Lamont Deyell Municipal Drain 2020					100.00%

NOTES:

- \* Denotes lands not eligible for ADIP grants.

## **APPENDIX 1**

**MAITLAND VALLEY CONSERVATION AUTHORITY – PERMIT TO ALTER A WATERCOURSE**

**PERMIT TO:** DEVELOP IN A REGULATED AREA  
X ALTER A WATERCOURSE

In accordance with Ontario Regulation 164/06 and amendments there to, permission has been granted to:

**Municipality of Morris-Turnberry**  
Address: 41342 Morris Rd., Brussels, Ontario N0G 1H0  
Location of works: Lot 19, Concession B, Turnberry Ward, Municipality of Morris-Turnberry,  
County of Huron; Thompson-Lamont-Deyell Municipal Drain  
Existing land use: Agriculture  
For the following works: Upgrades to the Thompson-Lamont-Deyell Municipal Drain from July 14,  
2020 to July 14, 2022, subject to the following conditions:

**SPECIFIC CONDITIONS:**

1. **All work must be carried out in conformance with the application, dated July 10<sup>th</sup>, 2020 signed by Chris Dietrich, and in accordance with the following:**
  - a. **Details for Thompson-Lamont-Deyell Municipal Drain 2020; under the stamp of W. J. Dietrich, April 30, 2020, including:**
    - i. **Drawing No. 1: Watershed Plan**
    - ii. **Drawing No. 2: Profile**
2. **MVCA requires site to be secured in a manner to ensure water events above base flow will pass unobstructed through site in a manner that prevents flooding upstream or erosion and sediment release downstream.**
3. **Works shall have regard for weather conditions and for potential rapid changes in those conditions.**
4. **Stock piles of overburden material shall not be kept beside or within the floodplain of the watercourse. MVCA prefers material to be removed from site as soon as possible unless needed to backfill.**
5. **Placed rip rap or field stone shall be sufficient to prevent erosion.**
6. **Equipment and materials should not be stored in the floodplain of the watercourse.**

**GENERAL CONDITIONS:**

The applicant, by acceptance of and in consideration of the issuance of this Permit, agrees to the following conditions:

1. This Permit does not preclude compliance from any other legislation, federal or provincial, or necessary approvals from the local municipality.
2. Authorized representatives of the Maitland Valley Conservation Authority (MVCA) may, at any time, enter onto the lands which are described herein in order to make any surveys, examinations, investigations, or inspections which are required for the purposes of ensuring the work(s) authorized by this Permit are being carried out according to the terms of the Permit.
3. The applicant agrees:
  - a) To indemnify and save harmless on a solicitor and client basis, the Maitland Valley Conservation Authority and its officers, employees, or agents, from any act or omission of the owner and/or applicant or any of his agents, employees or contractors relating to any of the particulars, terms of conditions of the Permit.
  - b) That this Permit shall not release the applicant from any legal liability or obligation and remains in force subject to all limitations, requirements and liabilities imposed by law;
  - c) That all complaints arising from the execution of the works authorized under this Permit shall be reported prior to the expiration of this Permit by the applicant to the Maitland Valley Conservation Authority.
  - d) That the Permit issued herein is based upon the plan(s) submitted to the Authority and the accuracy of the matters contained in the Application to the Authority.
4. This Permit is not assignable.

5. The applicant agrees that should the works be carried out contrary to the terms of this Permit, the Maitland Valley Conservation Authority may enter onto the property and cause the terms to be satisfied, at the expense of the applicant.

I agree to carry out or cause to be carried out the work(s) indicated above in compliance with the conditions set out herein and in accordance with the information contained in the application and any accompanying sketches. I realize should I carry out the work(s) contrary to the terms of this Permit, this Permit may be revoked. I also realize this Permit is valid only for the time period noted, and I agree to re-apply to the Authority prior to the expiration of this period should an extension be required.

Original Signed by (Applicants signature)  Date: July 16, 2020

**Signature of Authority Official**



**Stephen Jackson, P. Eng.**  
**Flood and Erosion Safety Services Coordinator**  
**MAITLAND VALLEY CONSERVATION AUTHORITY**

*Date: July 14, 2020*

**SPECIFICATIONS FOR THE CONSTRUCTION OF  
MUNICIPAL DRAINAGE WORKS**

**DIVISION A – General Conditions**

**DIVISION B – Specification for Open Drains**

**DIVISION H – Special Provisions**

## DIVISION A – GENERAL CONDITIONS

### TABLE OF CONTENTS

A.1.	Scope .....	1
A.2.	Tenders .....	1
A.3.	Examinations of Site, Drawings, and Specifications .....	1
A.4.	Payment.....	2
A.5.	Contractor’s Liability Insurance .....	2
A.6.	Losses Due to Acts of Nature, Etc.....	2
A.7.	Commencement and Completion of Work .....	2
A.8.	Working Area and Access .....	3
A.9.	Sub-Contractors.....	3
A.10.	Permits, Notices, Laws and Rules .....	3
A.11.	Railways, Highways, and Utilities .....	3
A.12.	Errors and Unusual Conditions.....	3
A.13.	Alterations and Additions.....	3
A.14.	Supervision .....	4
A.15.	Field Meetings .....	4
A.16.	Periodic and Final Inspections .....	4
A.17.	Acceptance By the Municipality .....	4
A.18.	Warranty.....	4
A.19.	Termination of Contract By The Municipality .....	4
A.20.	Tests.....	5
A.21.	Pollution.....	5
A.22.	Species and Risk.....	5
A.23.	Road Crossings.....	5
A.24.	Laneways .....	6
A.25.	Fences.....	7
A.26.	Livestock .....	7
A.27.	Standing Crops.....	7
A.28.	Surplus Gravel.....	7
A.29.	Iron Bars.....	7
A.30.	Rip-Rap.....	7
A.31.	Clearing, Grubbing and Brushing.....	7
A.32.	Restoration of Lawns.....	8





## **DIVISION A – GENERAL CONDITIONS**

### **A.1. Scope**

The work to be done under this contract consists of supplying all labour, equipment and materials to construct the drainage work as outlined in the Scope of Work, Drawings, General Conditions and other Specifications.

### **A.2. Tenders**

Tenders are to be submitted on a lump sum basis for the complete works or a portion thereof, as instructed by the Municipality. The Scope of Work must be completed and submitted with the Form of Tender and Agreement. A certified cheque is required as Tender Security, payable to the Treasurer of the Municipality.

All certified cheques, except that of the bidder to whom the work is awarded will be returned within ten (10) days after the tender closing. The certified cheque of the bidder to whom the work is awarded will be retained as Contract Security and returned when the Municipality receives a Completion Certificate for the work.

A certified cheque is not required if the Contractor provides an alternate form of Contract Security such as a Performance Bond for 100% of the amount of the Tender or other satisfactory security, if required/permitted by the Municipality. A Performance Bond may also be required to insure maintenance of the work for a period of one (1) year after the date of the Completion Certificate.

### **A.3. Examinations of Site, Drawings, and Specifications**

The Tenderer must examine the premises and site to compare them with the Drawings and Specifications in order to satisfy himself of the existing conditions and extent of the work to be done before submission of his Tender. No allowance shall subsequently be made on behalf of the Contractor by reason of any error on his part. Any estimates of quantities shown or indicated on the Drawings, or elsewhere are provided for the convenience of the Tenderer. Any use made of these quantities by the Tenderer in calculating his Tender shall be done at his own risk. The Tenderer for his own protection should check these quantities for accuracy.

The standard specifications (Divisions B through G) shall be considered complementary and where a project is controlled under one of the Divisions, the remaining Divisions will apply for miscellaneous works.

In case of any inconsistency or conflict between the Drawings and Specifications, the following order of precedence shall apply:

- Direction of the Engineer
- Special Provisions (Division H)
- Scope of Work
- Contract Drawings
- Standard Specifications (Divisions B through G)
- General Conditions (Division A)

#### **A.4. Payment**

Progress payments equal to 87±% of the value of work completed and materials incorporated in the work will be made to the Contractor monthly. An additional ten per cent (10±%) will be paid 45 days after the final acceptance by the Engineer, and three per cent (3±%) of the Contract price may be reserved by the Municipality as a maintenance holdback for a one (1) year period from the date of the Completion Certificate. A greater percentage of the Contract price may be reserved by the Municipality for the same one (1) year period if in the opinion of the Engineer, particular conditions of the Contract requires such greater holdback.

After the completion of the work, any part of this reserve may be used to correct defects developed within that time from faulty workmanship and materials, provided that notice shall first be given to the Contractor and that he may promptly make good such defects.

#### **A.5. Contractor's Liability Insurance**

Prior to commencement of any work, the Contractor shall file with the Municipality evidence of compliance with all Municipality insurance requirements (Liability Insurance, WSIB, etc.) for no less than the minimum amounts as stated in the Purchasing Procedures of the Municipality. All insurance coverage shall remain in force for the entire contract period including the warranty period which expires one year after the date of the Completion Certificate.

The following are to be named as co-insured:

- Successful Contractor
- Sub-Contractor Municipality
- Dietrich Engineering Ltd.

#### **A.6. Losses Due to Acts of Nature, Etc.**

All damage, loss, expense and delay incurred or experienced by the Contractor in the performance of the work, by reason of unanticipated difficulties, bad weather, strikes, acts of nature, or other mischances shall be borne by the Contractor and shall not be the subject of a claim for additional compensation.

#### **A.7. Commencement and Completion of Work**

The work must commence as specified in the Form of Tender and Agreement. If conditions are unsuitable due to poor weather, the Contractor may be required, at the discretion of the Engineer to postpone or halt work until conditions become acceptable and shall not be subject of a claim for additional compensation.

The Contractor shall give the Engineer a minimum of 48 hours notice before commencement of work. The Contractor shall then arrange a meeting to be held on the site with Contractor, Engineer, and affected Landowners to review in detail the construction scheduling and other details of the work.

If the Contractor leaves the job site for a period of time after initiation of work, he shall give the Engineer and the Municipality a minimum of 24 hours notice prior to returning to the project. If any work is commenced without notice to the Engineer, the Contractor shall be fully responsible for all such work undertaken prior to such notification.

The work must proceed in such a manner as to ensure its completion at the earliest possible date and within the time limit set out in the Form of Tender and Agreement.

**A.8. Working Area and Access**

Where any part of the drain is on a road allowance, the road allowance shall be the working area. For all other areas, the working area available to the Contractor to construct the drain is specified in the Special Provisions (Division H).

Should the specified widths become inadequate due to unusual conditions, the Contractor shall notify the Engineer immediately. Where the Contractor exceeds the specified working widths without authorization, he shall be held responsible for the costs of all additional damages.

If access off an adjacent road allowance is not possible, each Landowner on whose property the drainage works is to be constructed, shall designate access to and from the working area. The Contractor shall not enter any other lands without permission of the Landowner and he shall compensate the Landowner for damage caused by such entry.

**A.9. Sub-Contractors**

The Contractor shall not sublet the whole or part of this Contract without the approval of the Engineer.

**A.10. Permits, Notices, Laws and Rules**

The Contractor shall obtain and pay for all necessary permits or licenses required for the execution of the work (but this shall not include MTO encroachment permits, County Road permits permanent easement or rights of servitude). The Contractor shall give all necessary notices and pay for all fees required by law and comply with all laws, ordinances, rules and regulations relating to the work and to the preservation of the public's health and safety.

**A.11. Railways, Highways, and Utilities**

A minimum of 72 hours' notice to the Railway or Highways, exclusive of Saturdays, Sundays, and Statutory Holidays, is required by the Contractor prior to any work activities on or affecting the applicable property. In the case of affected Utilities, a minimum of 48 hours' notice to the utility owner is required.

**A.12. Errors and Unusual Conditions**

The Contractor shall notify the Engineer immediately of any error or unusual conditions which may be found. Any attempt by the Contractor to correct the error on his own shall be done at his own risk. Any additional cost incurred by the Contractor to remedy the wrong decision on his part shall be borne by the Contractor. The Engineer shall make the alterations necessary to correct errors or to adjust for unusual conditions during which time it will be the Contractor's responsibility to keep his men and equipment gainfully employed elsewhere on the project.

The Contract amount shall be adjusted in accordance with a fair evaluation of the work added or deleted.

**A.13. Alterations and Additions**

The Engineer shall have the power to make alterations in the work shown or described in the Drawings and Specifications and the Contractor shall proceed to make such changes without causing delay. In every such case, the price agreed to be paid for the work under the Contract shall be increased or decreased as the case may require according to a fair and reasonable evaluation of the work added or deleted. The valuation shall be determined as a result of negotiations between the Contractor and the Engineer, but in all cases the Engineer shall maintain the final responsibility for the decision. Such alterations and variations shall in no way render the Contract void. No claims for a variation or alteration in the increased or decreased price shall be valid unless done in pursuance of an order from the Engineer and notice of such claims made in writing before

commencement of such work. In no such case shall the Contractor commence work which he considers to be extra before receiving the Engineer's approval.

#### **A.14. Supervision**

The Contractor shall give the work his constant supervision and shall keep a competent foreman in charge at the site.

#### **A.15. Field Meetings**

At the discretion of the Engineer, a field meeting with the Contractor or his representative, the Engineer and with those others that the Engineer deems to be affected, shall be held at the location and time specified by the Engineer.

#### **A.16. Periodic and Final Inspections**

Periodic inspections by the Engineer will be made during the performance of the work. If ordered by the Engineer, the Contractor shall expose the drain as needed to facilitate inspection by the Engineer.

Final inspection by the Engineer will be made within twenty (20) days after he has received notice from the Contractor that the work is complete.

#### **A.17. Acceptance By the Municipality**

Before any work shall be accepted by the Municipality, the Contractor shall correct all deficiencies identified by the Engineer and the Contractor shall leave the site neat and presentable.

#### **A.18. Warranty**

The Contractor shall repair and make good any damages or faults in the drain that may appear within one (1) year after its completion (as dated on the Completion Certificate) as the result of the imperfect or defective work done or materials furnished if certified by the Engineer as being due to one or both of these causes; but nothing herein contained shall be construed as in any way restricting or limiting the liability of the Contractor under the laws of the Country, Province or Locality in which the work is being done. Neither the Completion Certificate nor any payment there under, nor any provision in the Contract Documents shall relieve the Contractor from his responsibility.

#### **A.19. Termination of Contract By The Municipality**

If the Contractor should be adjudged bankrupt, or if he should make a general assignment for the benefit of his creditors, or if a receiver should be appointed on account of his insolvency, or if he should refuse or fail to supply enough properly skilled workmen or proper materials after having received seven (7) days notice in writing from the Engineer to supply additional workmen or materials to commence or complete the works, or if he should fail to make prompt payment to Sub-Contractors, or for material, or labour, or persistently disregards laws, ordinances, or the instruction of the Engineer, or otherwise be guilty of a substantial violation of the provisions of the Contract, then the Municipality, upon the certificate of the Engineer that sufficient cause exists to justify such action, may without prejudice to any other right or remedy, by giving the Contractor written notice, terminate the employment of the Contractor and take possession of the premises, and of all materials, tools and appliances thereon, and may finish the work by whatever method the Engineer may deem expedient but without delay or expense. In such a case, the Contractor shall not be entitled to receive any further payment until the work is finished. If the unpaid balance of the Contract price will exceed the expense of finishing the work including compensation to the Engineer for his additional services and including the other damages of every name and nature, such excess shall be paid by the

Contractor. If such expense will exceed such unpaid balance, the Contractor shall pay the difference to the Municipality. The expense incurred by the Municipality, as herein provided, shall be certified by the Engineer.

If the Contract is terminated by the Municipality due to the Contractor's failure to properly commence the works, the Contractor shall forfeit the certified cheque bid deposit and furthermore shall pay to the Municipality an amount to cover the increased costs, if any, associated with a new Tender for the Contract being terminated.

If any unpaid balance and the certified cheque do not match the monies owed by the Contractor upon termination of the Contract, the Municipality may also charge such expense against any money which may thereafter be due to the Contractor from the Municipality.

#### **A.20. Tests**

The cost for the testing of materials supplied to the job by the Contractor shall be borne by the Contractor. The Engineer reserves the right to subject any lengths of any tile or pipe to a competent testing laboratory to ensure the adequacy of the tile or pipe. If any tile supplied by the Contractor is determined to be inadequate to meet the applicable A.S.T.M. standards, the Contractor shall bear full responsibility to remove and/or replace all such inadequate tile in the Contract with tile capable of meeting the A.S.T.M. Standards.

#### **A.21. Pollution**

The Contractor shall keep their equipment in good repair. The Contractor shall refuel or repair equipment away from open water.

If polluted material from construction materials or equipment is caused to flow into the drain, the Contractor shall immediately notify the Ministry of the Environment, and proceed with the Ministry's protocols in place to address the situation.

#### **A.22. Species and Risk**

If a Contractor encounters a known Species at Risk as designated by the MNR or DFO, the Contractor shall notify the Engineer immediately and follow the Ministry's guidelines to deal with the species.

#### **A.23. Road Crossings**

This specification applies to all road crossings (Municipality, County, Regional, or Highway) where no specific detail is provided on the drawings or in the standard specifications. This specification in no way limits the Road Authority's regulations governing the construction of drains on their Road Allowance.

##### **A.23.1 Road Occupancy Permit**

Where applicable, the Contractor must submit an application for a road occupancy permit to the Road Authority and allow a minimum of five (5) working days for its review and issuance.

##### **A.23.2 Road Closure Request and Construction Notification**

The Contractor shall submit written notification of construction and request for road closure (if applicable) to the Road Authority and the Engineer for review and approval a minimum of five (5) working days prior to proceeding with any work on the road allowance. The Contractor shall be responsible for notifying all applicable emergency services, schools, etc. of the road closure or construction taking place.

### **A.23.3 Traffic Control**

The Contractor shall supply flagmen, and warning signs and ensure that detour routes are adequately signed in accordance with no less than the minimum standards as set out in the Ontario Traffic Manual's Book 7.

### **A.23.4 Weather**

No construction shall take place during inclement weather or periods of poor visibility.

### **A.23.5 Equipment**

No construction material and/or equipment is to be left within three (3) metres of the travelled portion of the road overnight or during periods of inclement weather.

If not stated on the drawings, the road crossing shall be constructed by open cut method. Backfill from the top of the cover material over the subsurface pipe or culvert to the under side of the road base shall be Granular "B". The backfill shall be placed in lifts not exceeding 300mm in thickness and each lift shall be thoroughly compacted to 98% Standard Proctor. Granular "B" road base for County Roads and Highways shall be placed to a 450mm thickness and Granular "A" shall be placed to a thickness of 200mm. Granular road base materials shall be thoroughly compacted to 100% Standard Proctor.

Where the road surface is paved, the Contractor shall be responsible for placing HL-8 Hot Mix Asphalt patch at a thickness of 50mm or of the same thickness as the existing pavement structure. The asphalt patch shall be flush with the existing roadway on each side and without overlap.

Excavated material from the trench beyond 1.25 metres from the travelled portion or beyond the outside edge of the gravel shoulder may be used as backfill in the trench in the case of covered drains. The material shall be compacted in lifts not exceeding 300mm.

## **A.24. Laneways**

All pipes crossing laneways shall be backfilled with material that is clean, free of foreign material or frozen particles and readily tamped or compacted in place unless otherwise specified. Laneway culverts on open ditch projects shall be backfilled with material that is not easily erodible. All backfill material shall be thoroughly compacted as directed by the Engineer.

Culverts shall be bedded with a minimum of 300mm of granular material. Granular material shall be placed simultaneously on each side of the culvert in lifts not exceeding 150mm in thickness and compacted to 95% Standard Proctor Density. Culverts shall be installed a minimum of 10% of the culvert diameter below design grade with a minimum of 450mm of cover over the pipe unless otherwise noted on the Drawings.

The backfill over culverts and subsurface pipes at all existing laneways that have granular surfaces on open ditch and closed drainage projects shall be surfaced with a minimum of 300mm of Granular "B" material and 150mm of Granular "A" material. All backfill shall be thoroughly compacted as directed by the Engineer. All granular material shall be placed to the full width of the travelled portion.

Any settling of backfilled material shall be repaired by or at the expense of the Contractor during the warranty period of the project and as soon as required.

**A.25. Fences**

No earth is to be placed against fences and all fences removed by the Contractor shall be replaced by him in as good a condition as found. Where practical the Contractor shall take down existing fences in good condition at the nearest anchor post and roll it back rather than cutting the fence and attempting to patch it. The replacement of the fences shall be done to the satisfaction of the Engineer. Any fences found in such poor condition where the fence is not salvageable, shall be noted and verified with the Engineer prior to commencement of work.

Fences damaged beyond repair by the Contractor's negligence shall be replaced with new materials, similar to those materials of the existing fence, at the Contractor's expense. The replacement of the fences shall be done to the satisfaction of the Landowner and the Engineer.

Any fences paralleling an open ditch that are not line fences that hinder the proper working of the excavating machinery, shall be removed and rebuilt by the Landowner at his own expense.

The Contractor shall not leave fences open when he is not at work in the immediate vicinity.

**A.26. Livestock**

The Contractor shall provide each landowner with 48 hours notice prior to removing any fences along fields which could possibly contain livestock. Thereafter, the Landowner shall be responsible to keep all livestock clear of the construction areas until further notified. The Contractor shall be held responsible for loss or injury to livestock or damage caused by livestock where the Contractor failed to notify the Landowner, or through negligence or carelessness on the part of the Contractor.

**A.27. Standing Crops**

The Contractor shall be responsible for damages to standing crops which are ready to be harvested or salvaged along the course of the drain and access routes if the Contractor has failed to notify the Landowners 48 hours prior to commencement of the work on that portion of the drain.

**A.28. Surplus Gravel**

If as a result of any work, gravel or crushed stone is required and not all the gravel or crushed stone is used, the Contractor shall haul away such surplus material.

**A.29. Iron Bars**

The Contractor is responsible for the cost of an Ontario Land Surveyor to replace any iron bars that are altered or destroyed during the course of the construction.

**A.30. Rip-Rap**

Rip-rap shall be quarry stone rip-rap material and shall be the sizes specified in the Special Provisions. Broken concrete shall not be used as rip-rap unless otherwise specified.

**A.31. Clearing, Grubbing and Brushing**

This specification applies to all brushing where no specific detail is provided on the drawings or in the Special Provisions.

The Contractor shall clear, brush and stump trees from within the working area that interfere with the installation of the drainage system.

All trees, limbs and brush less than 150mm in diameter shall be mulched. Trees greater than 150mm in diameter shall be cut and neatly stacked in piles designated by the Landowners.

### **A.32. Restoration of Lawns**

This specification applies to all lawn restoration where no specific detail is provided on the drawings or in the Special Provisions and no allowance for damages has been provided under Section 30 of the Drainage Act RSO 1990 to the affected property.

The Contractor shall supply “high quality grass seed” and the seed shall be broadcast by means of an approved mechanical spreader. All areas on which seed is to be placed shall be loose at the time of broadcast to a depth of 25mm. Seed and fertilizer shall be spread in accordance with the supplier’s recommendations unless otherwise directed by the Engineer. Thereafter it will be the responsibility of the Landowner to maintain the area in a manner so as to promote growth

**END OF DIVISION**



**DIVISION B – SPECIFICATIONS FOR OPEN DRAINS**

**TABLE OF CONTENTS**

B.1. Alignment .....1

B.2. Profile.....1

B.3. Excavation.....1

B.4. Excavated Material .....1

B.5. Excavation at Existing Bridge and Culvert Sites.....2

B.6. Pipe Culverts .....2

B.7. Rip-Rap Protection For Culverts .....2

B.8. Clearing, Grubbing and Mulching.....2

B.9. Tributary Tile Outlets.....3

B.10. Seeding .....3

B.11. Hydro Seeding.....3

B.12. Hand Seeding.....3

B.13. Completion .....3



## DIVISION B – SPECIFICATIONS FOR OPEN DRAINS

### B.1. Alignment

The drain shall be constructed in a straight line and shall follow the course of the present drain or water run unless noted on the drawings. Where there are unnecessary bends or irregularities on the existing course of the drain, the Contractor shall contact the Engineer before commencing work to verify the manner in which such irregularities or bends may be removed from the drain. All curves shall be made with a minimum radius of fifteen (15) metres from the centre line of the drain.

### B.2. Profile

The Profile Drawing shows the depth of cuts from the top of the bank to the final invert of the ditch in metres and decimals of a metre, and also the approximate depth of excavated material from the bottom of the existing ditch to the final invert of the ditch. These cuts are established for the convenience of the Contractor; however, bench marks (established along the course of the drain) will govern the final elevation of the drain. The location and elevation of the bench marks are given on the Profile Drawing. Accurate grade control must be maintained by the Contractor during ditch excavation.

### B.3. Excavation

The bottom width and the side slopes of the ditch shall be those shown on the drawings. If the channel cross-section is not specified it shall be a one metre bottom width with 1.5(h):1(v) side slopes. At locations along the drain where the cross section dimensions change, there shall be a transitional length of not less than 10:1 (five metre length to 0.5 metre width differential). Where the width of the bottom of the existing ditch is sufficient to construct the design width, then construction shall proceed without disturbing the existing banks.

Where existing side slopes become unstable, the Contractor shall immediately notify the Engineer. Alternative methods of construction and/or methods of protection will then be determined prior to continuing work.

Where an existing drain is being relocated or where a new drain is being constructed, the Contractor shall strip the topsoil for the full width of the drain, including the location of the spoil pile. Upon completion of levelling, the topsoil shall be spread to an even depth across the full width of the spoil.

An approved hydraulic excavator shall be used to carry out the excavation of the open ditch unless otherwise directed by the Engineer.

### B.4. Excavated Material

Excavated material shall be placed on the low side of the drain or opposite trees and fences. The Contractor shall contact all Landowners before proceeding with the work to verify the location to place and level the excavated material.

No excavated material shall be placed in tributary drains, depressions, or low areas which direct water behind the spoil bank. The excavated material shall be placed and levelled to a maximum depth of 200 mm, unless instructed otherwise and commence a minimum of one (1) metre from the top of the bank. The edge of the spoil bank away from the ditch shall be feathered down to the existing ground; the edge of the spoil bank nearest the ditch shall have a maximum slope of 2(h):1(v). The material shall be levelled such that it may be

cultivated with ordinary farm equipment without causing undue hardship to the farm machinery and farm personnel. No excavated material shall cover any logs, brush, etc. of any kind.

Any stones or boulders which exceed 300mm in diameter shall be removed and disposed of in a location specified by the Landowner.

Where it is necessary to straighten any unnecessary bends or irregularities in the alignment of the ditch or to relocate any portion or all of an existing ditch, the excavated material from the new cut shall be used for backfilling the original ditch. Regardless of the distance between the new ditch and the old ditch, no extra compensation will be allowed for this work and must be included in the Contractor's lump sum price for the open work.

#### **B.5. Excavation at Existing Bridge and Culvert Sites**

The Contractor shall excavate the drain to the full specified depth under all bridges and to the full width of the structure. Temporary bridges may be carefully removed and left on the bank of the drain but shall be replaced by the Contractor when the excavation is complete. Permanent bridges must, if at all possible, be left intact. All necessary care and precautions shall be taken to protect the structure. The Contractor shall notify the Landowner if excavation will expose the footings or otherwise compromise the structural integrity of the structure.

The Contractor shall clean through all pipe culverts to the grade and width specified on the profile.

#### **B.6. Pipe Culverts**

All pipe culverts shall be installed in accordance with the standard detail drawings. If couplers are required, five corrugation couplers shall be used for up to and including 1200mm diameter pipes and 10 corrugation couplers for greater than 1200mm diameter pipes.

When an existing crossing is being replaced, the Contractor may backfill the new culvert with the existing native material that is free of large rocks and stones. The Contractor is responsible for any damage to a culvert pipe that is a result of rocks or stones in the backfill.

#### **B.7. Rip-Rap Protection For Culverts**

Quarry stone rip-rap shall be used as end treatment for new culverts and placed on geotextile filter material (Mirafi 160N or approved equal). The rip-rap shall be adequately keyed in along the bottom of the slope, and shall extend to the top of the pipe or as directed on the drawings. The maximum slope for rip-rap shall be 1(h):1(v) or as directed by the Engineer.

The Contractor shall be responsible for any defects or damages that may develop in the rip-rap or the earth behind the rip-rap that the Engineer deems to have been fully or partially caused by faulty workmanship or materials.

#### **B.8. Clearing, Grubbing and Mulching**

Prior to excavation, all trees, scrub, fallen timber and debris shall be removed from the side slopes of the ditch and for such a distance on the working side so as to eliminate any interference with the construction of the drain or the spreading of the spoil. The side slopes shall be neatly cut and cleared flush with the slope whether or not they are affected directly by the excavation. With the exception of large stumps causing damage to the drain, the side slopes shall not be grubbed. All other cleared areas shall be grubbed and the stumps put into piles for disposal by the Landowner.

All trees or limbs 150mm or larger, that is necessary to remove, shall be cut, trimmed and neatly stacked in the working width for the use or disposal by the Landowner. Brush and limbs less than 150mm in diameter shall be mulched. Clearing, grubbing and mulching shall be carried out as a separate operation from the excavation of the ditch, and shall not be completed simultaneously at the same location.

#### **B.9. Tributary Tile Outlets**

All tile outlets in existing ditches shall be marked by the Landowner prior to excavation. The Contractor shall guard against damaging the outlets of tributary drains. Any tile drain outlets that were marked or noted on the drawings and are subsequently damaged by the Contractor shall be repaired by the Contractor at his expense. The Landowner shall be responsible for repairs to damaged tile outlets that were not marked.

#### **B.10. Seeding**

The side slopes where disturbed shall be seeded using an approved grass seed mixture. The grass seed shall be applied the same day as the excavation of the open ditch.

Grass seed shall be fresh, clean and new crop seed, meeting the requirements of the MTO and composed of the following varieties mixed in the proportion by weight as follows:

- 55% Creeping Red Fescue
- 40% Perennial Rye Grass
- 5% White Clover

Grass seed shall be applied at the rate of 100 kg/ha.

#### **B.11. Hydro Seeding**

The areas specified in the contract document shall be hydro seeded and mulched upon completion of construction in accordance with O.P.S.S. 572.

#### **B.12. Hand Seeding**

Placement of the seed shall be of means of an approved mechanical spreader.

#### **B.13. Completion**

At the time of completion and final inspection, all work in the Contract shall have the full dimensions and cross-sections specified without any allowance for caving of banks or sediment in the ditch bottom.

**END OF DIVISION**





## DIVISION H – SPECIAL PROVISIONS

### TABLE OF CONTENTS

H.1	General .....	1
H.2	Utilities.....	1
H.3	Working Area And Access.....	1
H.4	Crossing Construction.....	1
H.5	Culvert Length .....	2





## DIVISION H – SPECIAL PROVISIONS

Thompson Lamont Deyell Municipal Drain 2020  
Municipality of Morris-Turnberry

Reference No. 1756

Special provisions means special directions containing requirements peculiar to the work not adequately provided for by the standard or supplemental Specifications. Special provisions shall take precedence and govern any standard or supplemental Specifications.

### H.1 General

The Contractor shall notify the Landowners, the Drainage Superintendent and the Engineer forty-eight (48) hours prior to construction and arrange a pre-construction meeting.

The Contractor shall verify the location of the new crossing with the Engineer and landowners prior to construction.

The Contractor shall check and verify all dimensions and elevations and report any discrepancies to the Engineer prior to proceeding with the work.

### H.2 Utilities

All utilities shall be located and uncovered in the affected areas by the Contractor prior to construction.

The locations and elevations of all utilities shown on the drawings are approximate locations. Actual locations and elevations of all utilities must be verified by the Contractor prior to construction.

The Contractor shall arrange to have a representative of the utility owner on site during construction if it is a requirement by the utility owner.

### H.3 Working Area And Access

The working area for the crossing shall be a width of ten (10) metres from each side of the drain for a distance of ten (10) metres from each end of the crossing. The Contractor shall use the existing laneway to access the working area.

### H.4 Crossing Construction

#### H.4.1 Dewatering and Working in the Dry

Construction of the crossing shall occur during low flow conditions, and the Contractor shall implement a flow diversion scheme to keep the working area free of any excess water.

If the Contractor expects poor weather before completing construction, the Contractor shall make sure to prepare the construction site so to minimize the amount of sediment transport during the rainfall event.

#### H.4.2 Removals

The Contractor shall remove the existing crossing, and any other debris currently situated on the streambed in the location of the proposed crossing including offsite disposal.

All excess excavated material from the construction of the crossing shall be hauled off site.

### **H.4.3 Crossing Construction**

The crossing shall be constructed in accordance with the attached crossing detail.

The Contractor shall supply all necessary materials and equipment to construct the crossing and crossing approaches.

All stone rip-rap material shall be quarry stone 150 mm to 300 mm dia. and placed to a depth of 450 mm. All rip-rap material shall be placed on geo-textile filter material (Mirafi 180N).

### **H.4.4 Restoration**

The Contractor shall supply and spread an approved grass seed and fertilizer mixture over all disturbed side slopes where rip-rap will not be placed.

### **H.5 Culvert Length**

The Contractor shall supply the culvert in 1 - 13 metre length with no couplers.

**END OF DIVISION**

*THOMPSON LAMONT DEYELL MUNICIPAL DRAIN  
 E. CZERNIAWSKI PROPERTY (15-007)  
 LOT 19, CONCESSION B  
 MUNICIPALITY OF MORRIS-TURNBERRY (TURNBERRY WARD)  
 LANEWAY CULVERT DETAIL*

<u>DIAMETER</u>	<u>LENGTH</u>	<u>INVERT</u>	<u>CORRUGATIONS</u>	<u>THICKNESS</u>
2400mm	13m	D.S.E. = 303.00 U.S.E. = 303.03	125mm x 25mm	2.80mm

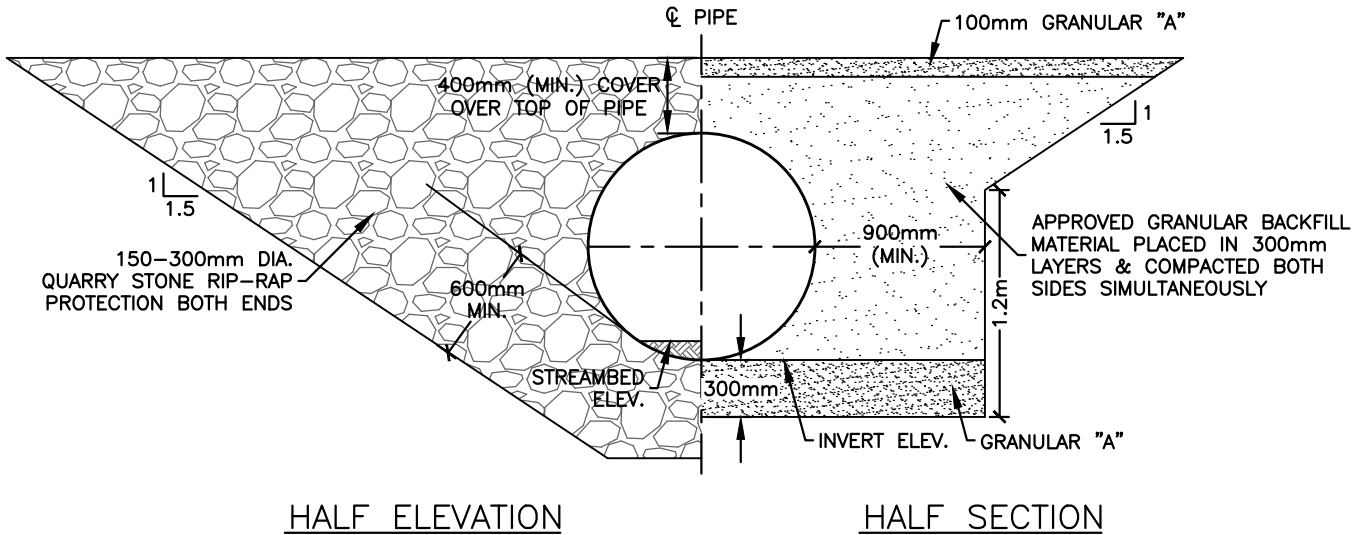

N.T.S.

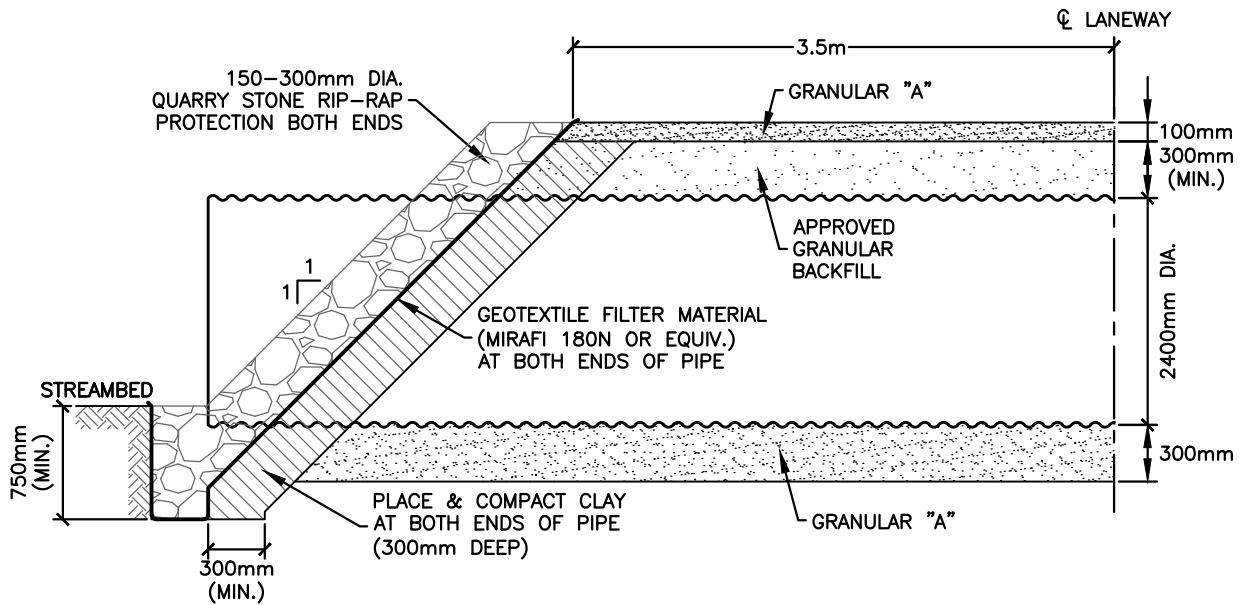

N.T.S.

*TOWNSHIP OF HURON-KINLOSS  
(KINLOSS WARD)  
COUNTY OF BRUCE*

*MUNICIPALITY OF SOUTH BRUCE  
(CULROSS WARD)  
COUNTY OF BRUCE*



*TOWNSHIP OF NORTH HURON  
(EAST WAWANOSH WARD)  
COUNTY OF HURON*

*MUNICIPALITY OF MORRIS-TURNBERRY  
(TURNBERRY WARD)  
COUNTY OF HURON*

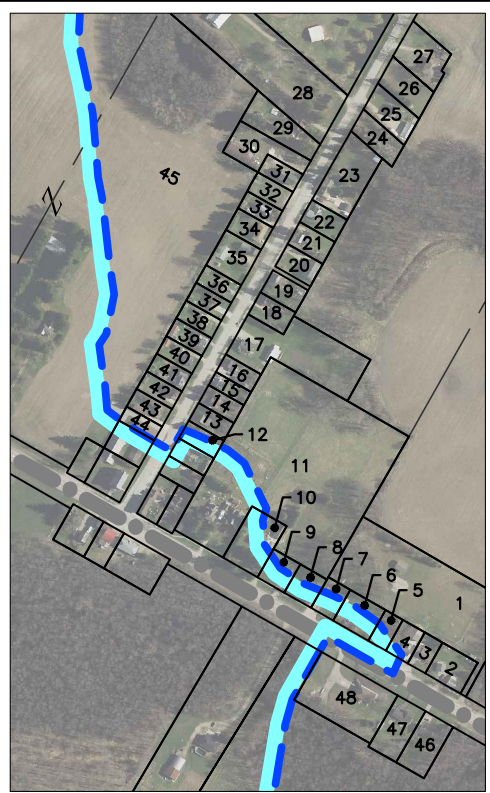

**WHITECHURCH DETAIL**

N.T.S.

No.	NAME	ROLL No.
1	TOWNSHIP OF HURON-KINLOSS	2-008
2	M. JOSEPH	2-006
3	T. FALCONER	2-009
4	C. DALE	2-010
5	D. ROSS	2-011
6	D. PREISS	2-013
7	M. LYONS	2-014
8	M. THOMSON	2-015
9	J. HOGG	2-016
10	L. SMITS	2-017
11	M. CARRIERE	2-018
12	D. METCALFE	2-023
13	J. FRANKEN	2-024
14	J. DICKIE	2-025
15	I. WALKER	2-026
16	C. HUMPHREY	2-027
17	A. PENNINGTON	2-028
18	R. WARD	2-031
19	A. FURNESS	2-032
20	L. GRAUMANS	2-033
21	K. MOORE	2-034
22	H. TURNER	2-035
23	J. HUGHES	2-036
24	W. SIMPSON	2-036-10
25	R. HARRIS	2-039-02
26	M. SIMPSON	2-039-01
27	J. LETTAU	2-039
28	G. POTTER	2-045-20
29	S. SUTHERLAND	2-045
30	J. SHEPERD	2-046
31	D. THOMPSON	2-047
32	M. SHAIK	2-048
33	J. FRANKEN	2-049
34	G. HOGGARTH	2-050
35	A. GREGORY	2-051
36	K. HILDENBRANDT	2-054
37	T. WRIGHT	2-053
38	M. TAYLOR	2-055
39	J. LITTLE	2-056
40	B. BENNINGER	2-057
41	J. COULTER	2-058
42	P. BRINK	2-059
43	J. GIBSON	2-060
44	TOWNSHIP OF HURON-KINLOSS	2-061
45	E. MILLER	2-065
46	J. FRANKEN	14-014
47	J. BANK	14-013
48	M. McCORMICK	14-010

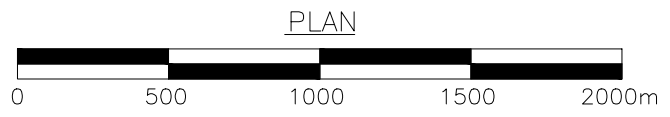

PROJECT: THOMPSON LAMONT DEYELL MUNICIPAL DRAIN 2020

DRAWING: **Watershed Plan**

DATE: AUGUST 7, 2020

DRAWING NO.: 1 of 2

PROJECT NO.: 1756

**DEL**  
DIETRICH ENGINEERING LIMITED  
CONSULTING ENGINEERS  
10 Alpine Court, Kitchener, ON, N2E 2M7

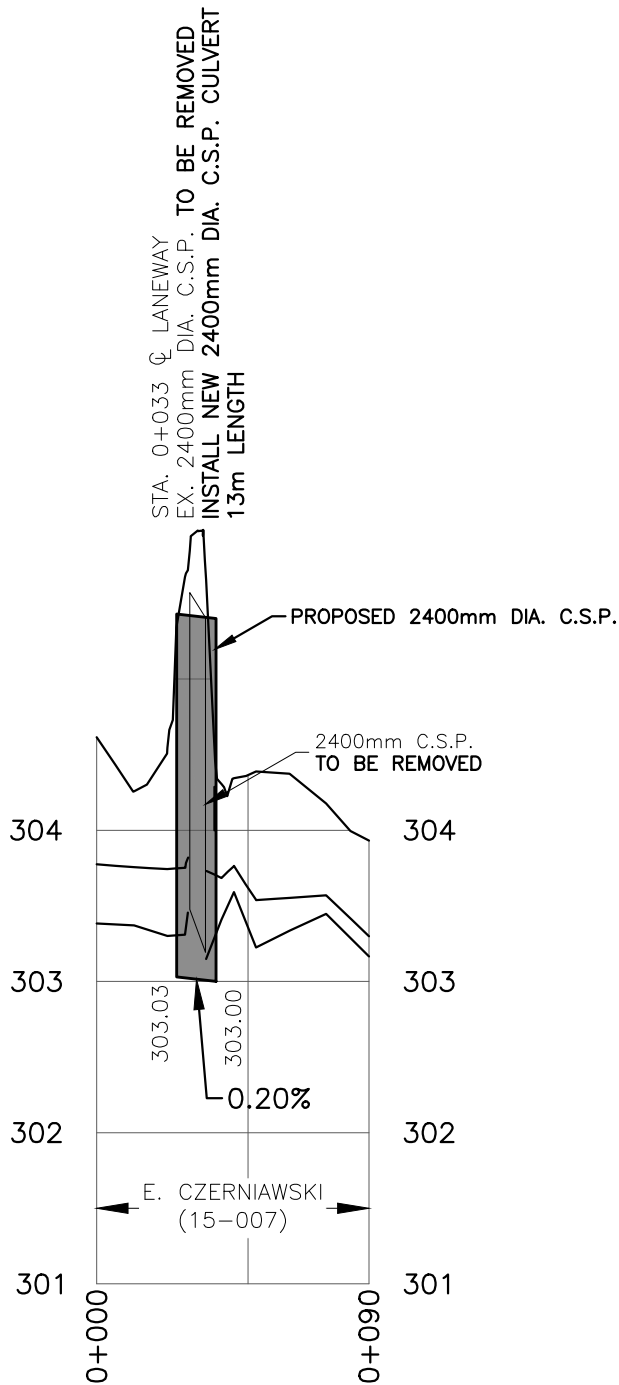

PROFILE SCALES

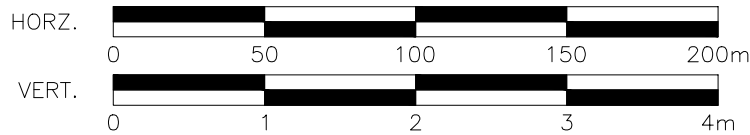

PROJECT:

**THOMPSON LAMONT DEYELL MUNICIPAL DRAIN 2020**



DRAWING:

Profile

DATE:  
AUGUST 7, 2020

DRAWING NO.:  
2 of 2

PROJECT NO.:  
1756

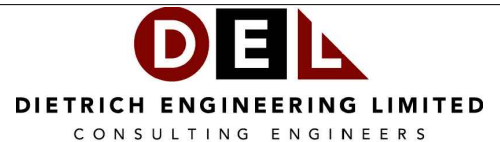

10 Alpine Court, Kitchener, ON, N2E 2M7